



 Hoco Lex

511



 Hoco Lex

511



511



 HocoLex

505

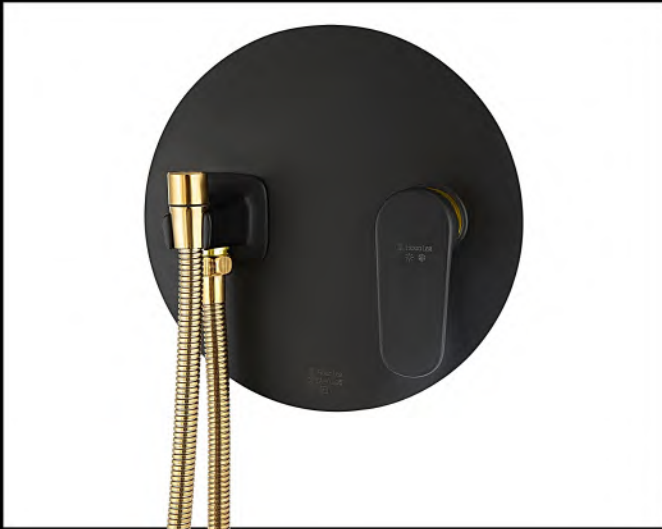



512



509

509

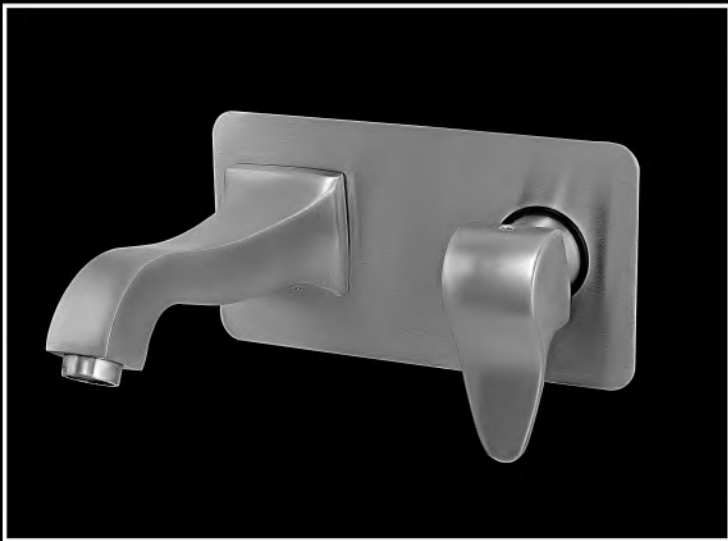
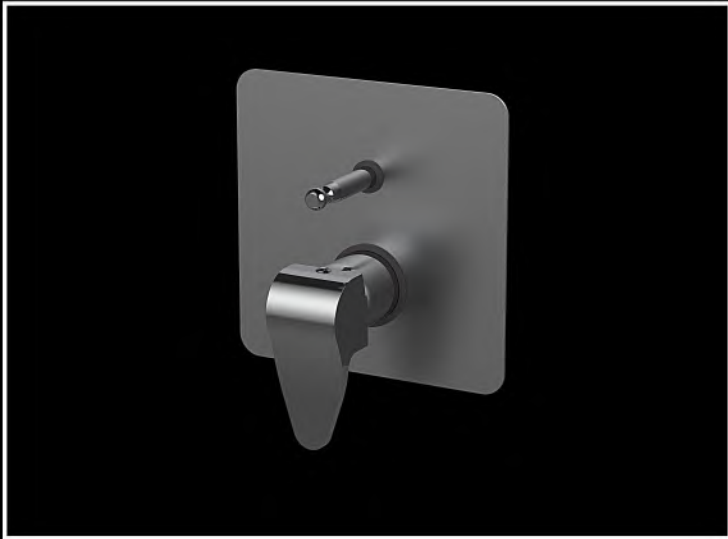

 HocoLex

509





515

 HocoLex

515



HI Hoco Lex



- شیر آشپزخانه شآوری ، جهت پوشش فضای بیشتر شست و شو
- کاتریج سرامیکی مقاوم در برابر سرما و گرما
- پوشش PVD مطابق با استاندارد روز دنیا
- ساختار آرگونومیک
- نصب سریع و آسان

514



 Hoco Lex



513

collection



513



513



513

 HocoLex





516

 HocoLex

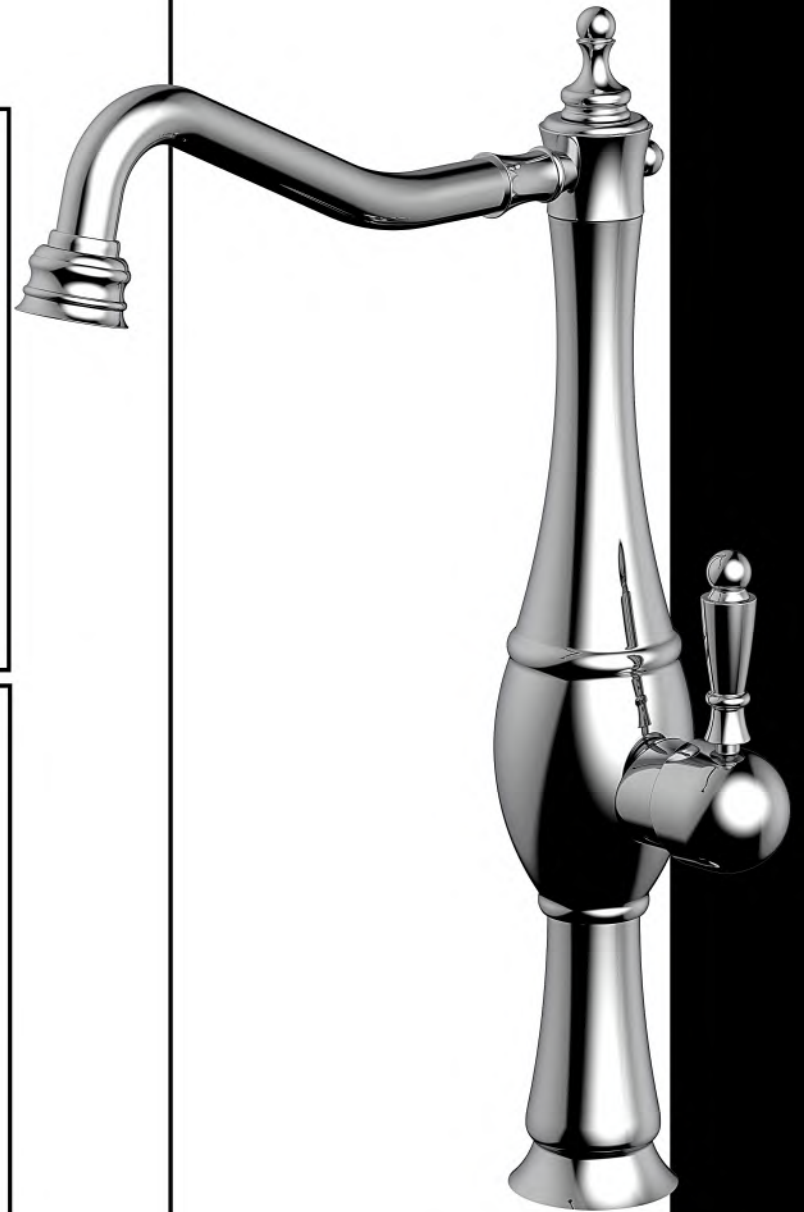

510
collection

The Eye of the
Sahara



510



 HocoLex

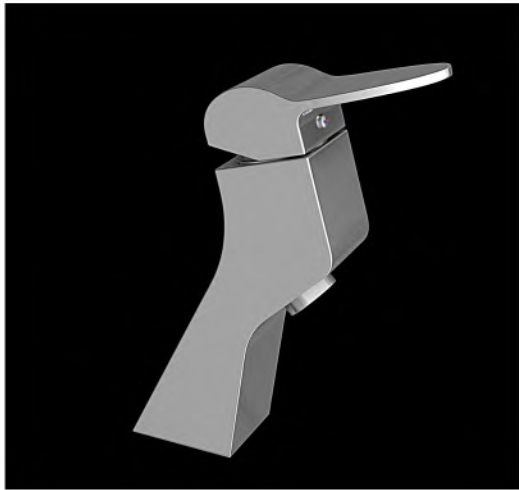
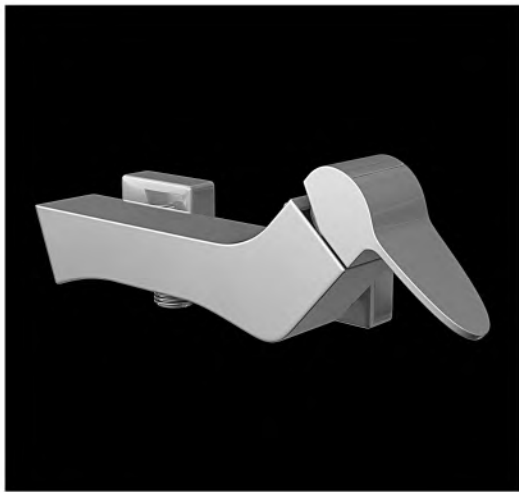

509

HL Hoco Lex





 Hoco Lex



534

collection



 Hoco Lex
534

Time makes
the carbon
a diamond.



534



508

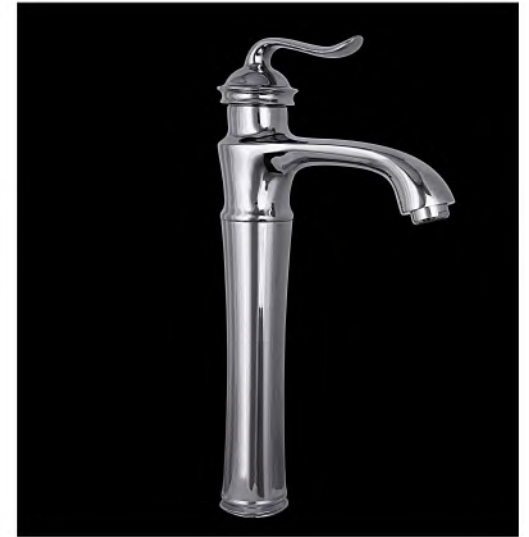

508



 Hoco Lex

508



 Hoco Lex



511
collection

511



 HocoLex

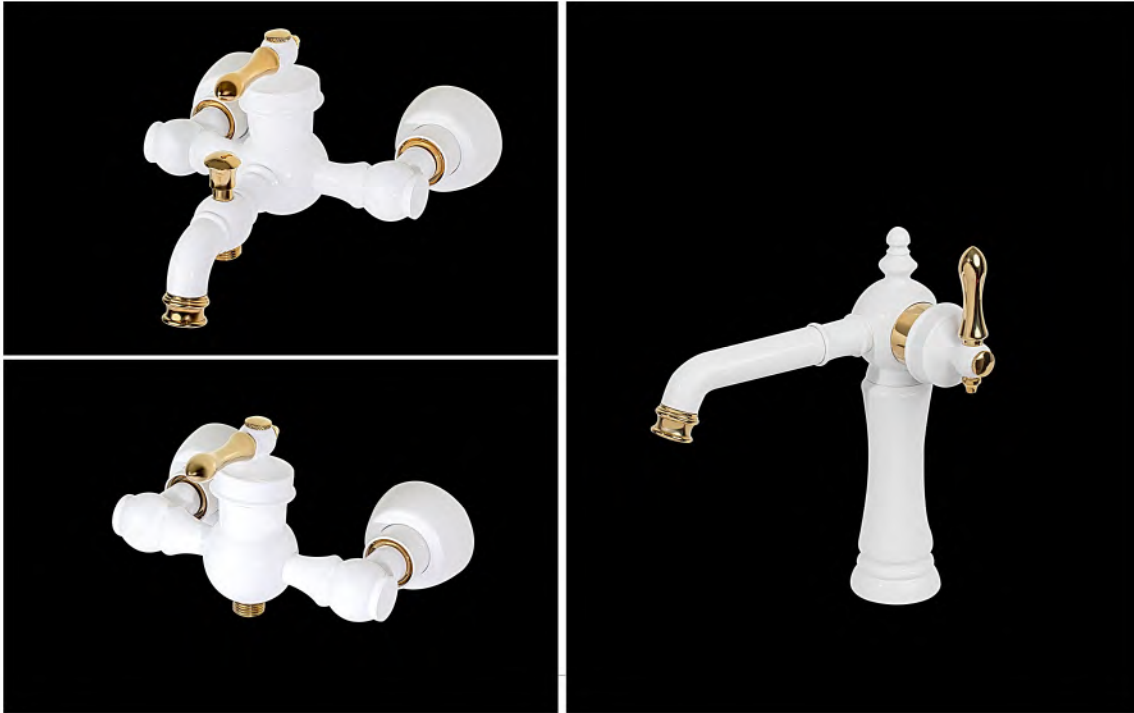

 HocoLex

505
collection



505



 Hoco Lex





506
collection

power of beauty
 HocoLex

506

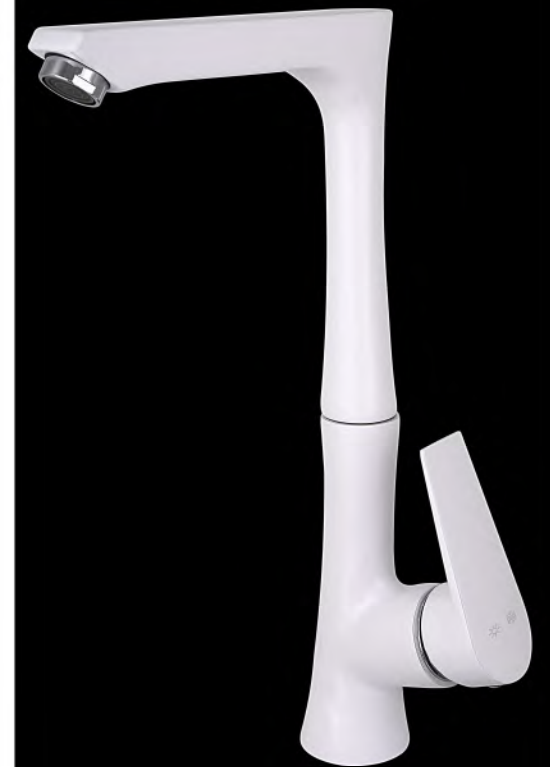
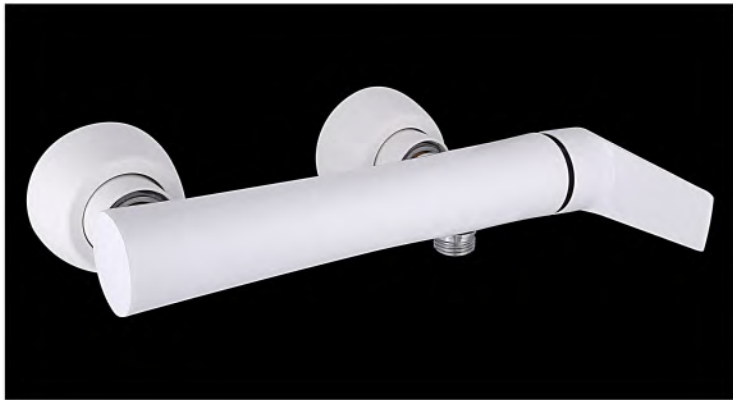

 Hoco Lex

506



 Hoco Lex



537
collection

 HocoLex







512

 Hoco Lex

**512
collection**



512





 Hoco Lex

512



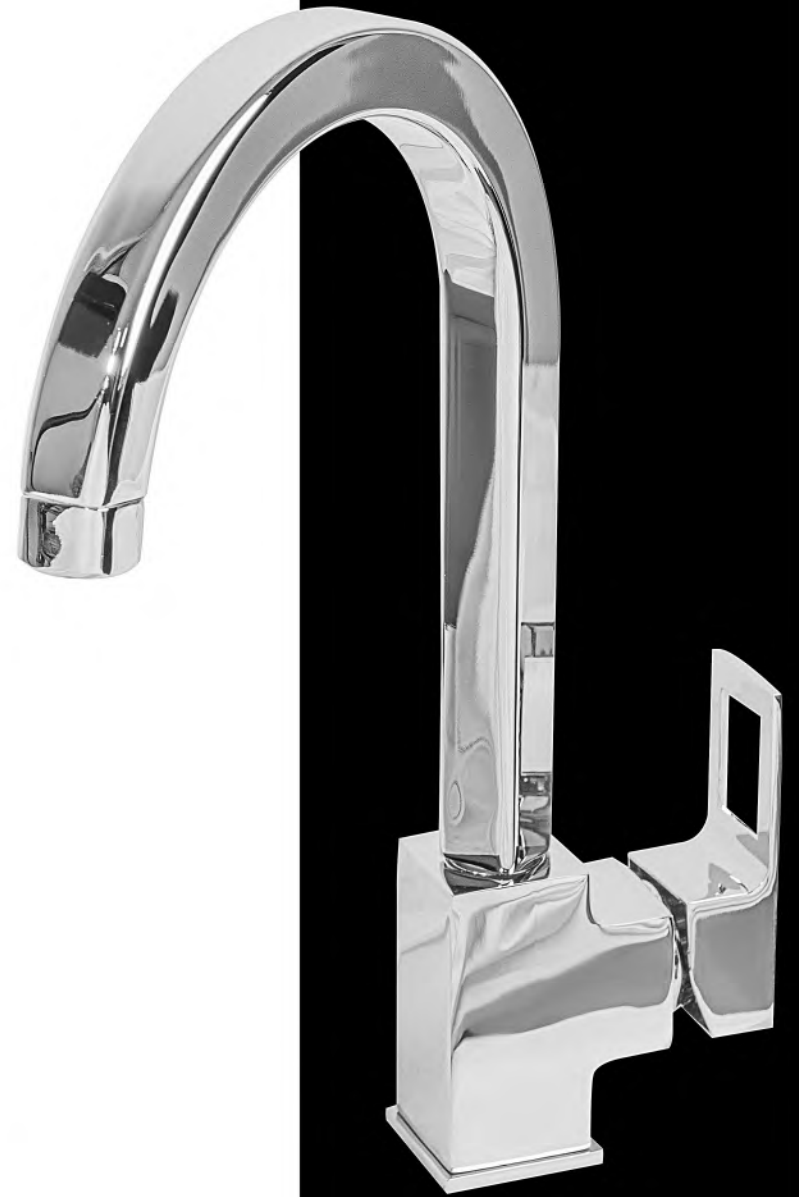



 HocoLex

501



water is driver of nature



501

502



 HogcoLex



522

 HocoLex



521

 HocoLex



521

 HocoLex



523

 HocoLex

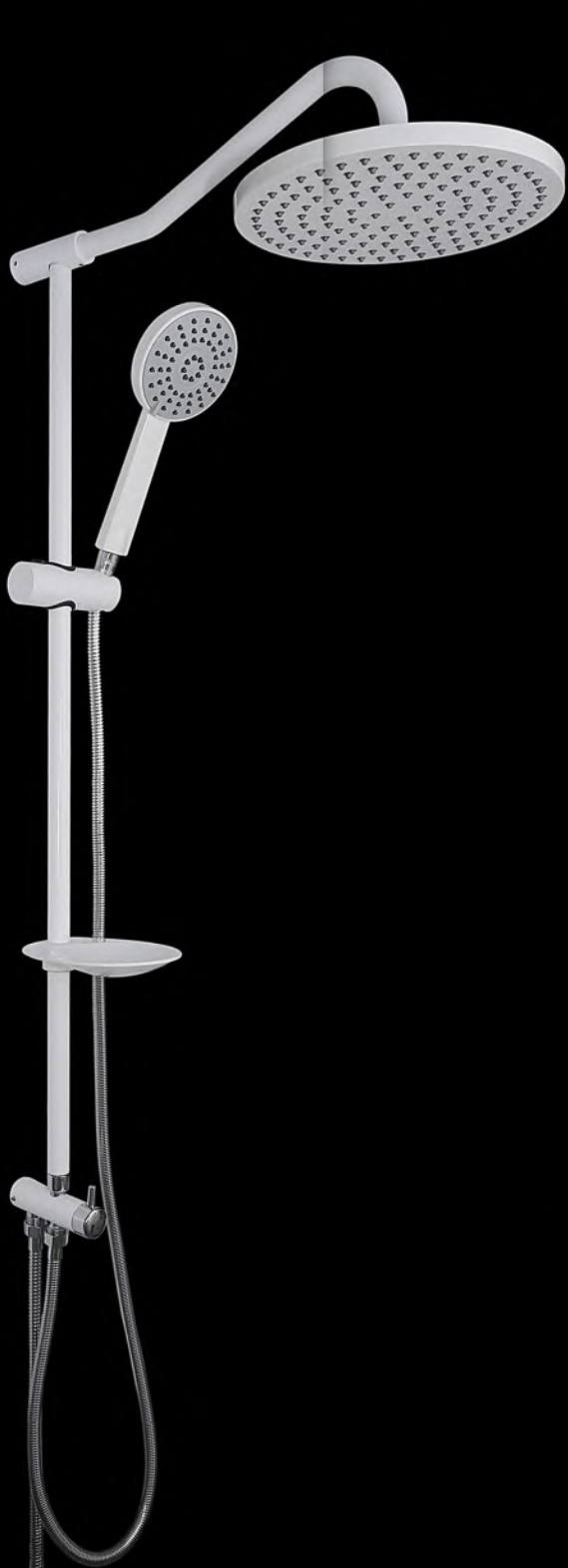

522

 HocoLex



522

 Hoco Lex

520

 Hoco Lex



519



 Hoco Lex

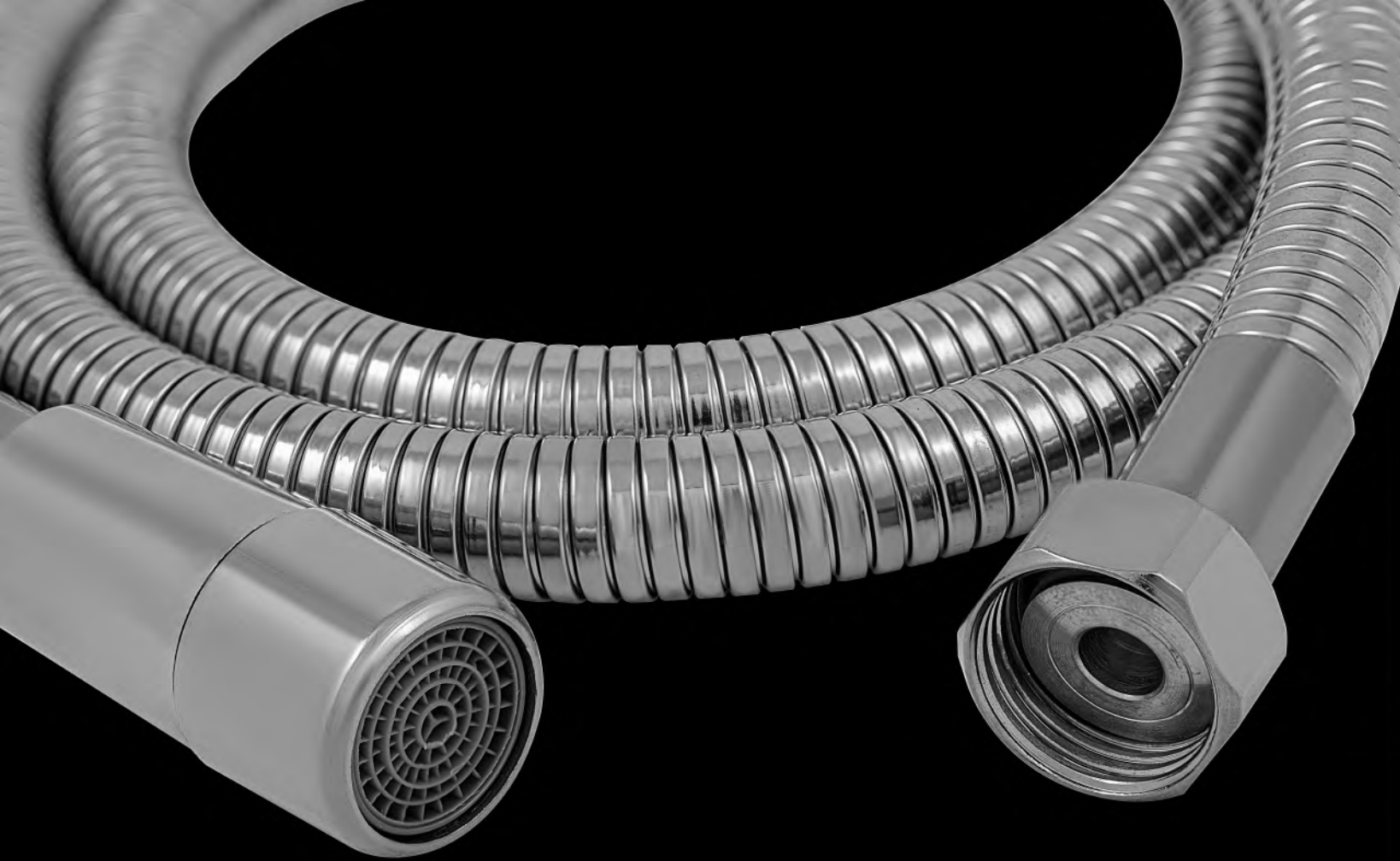

 HocoLex



 HocoLex



 HocoLex



 HocoLex



 HocoLex



 HocoLex



 HocoLex



 HocoLex



 Hoco Lex



AVAND



ARAX

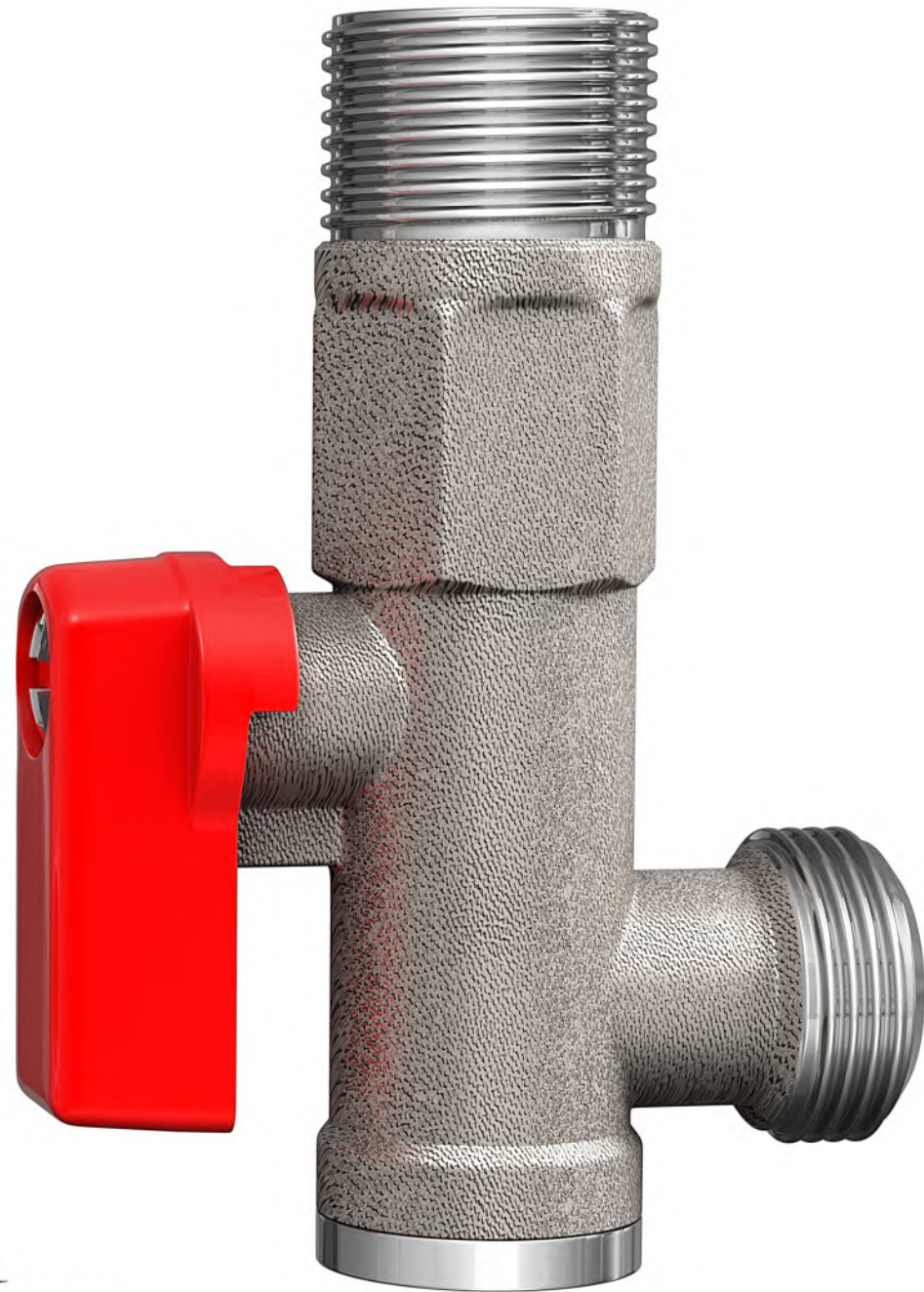
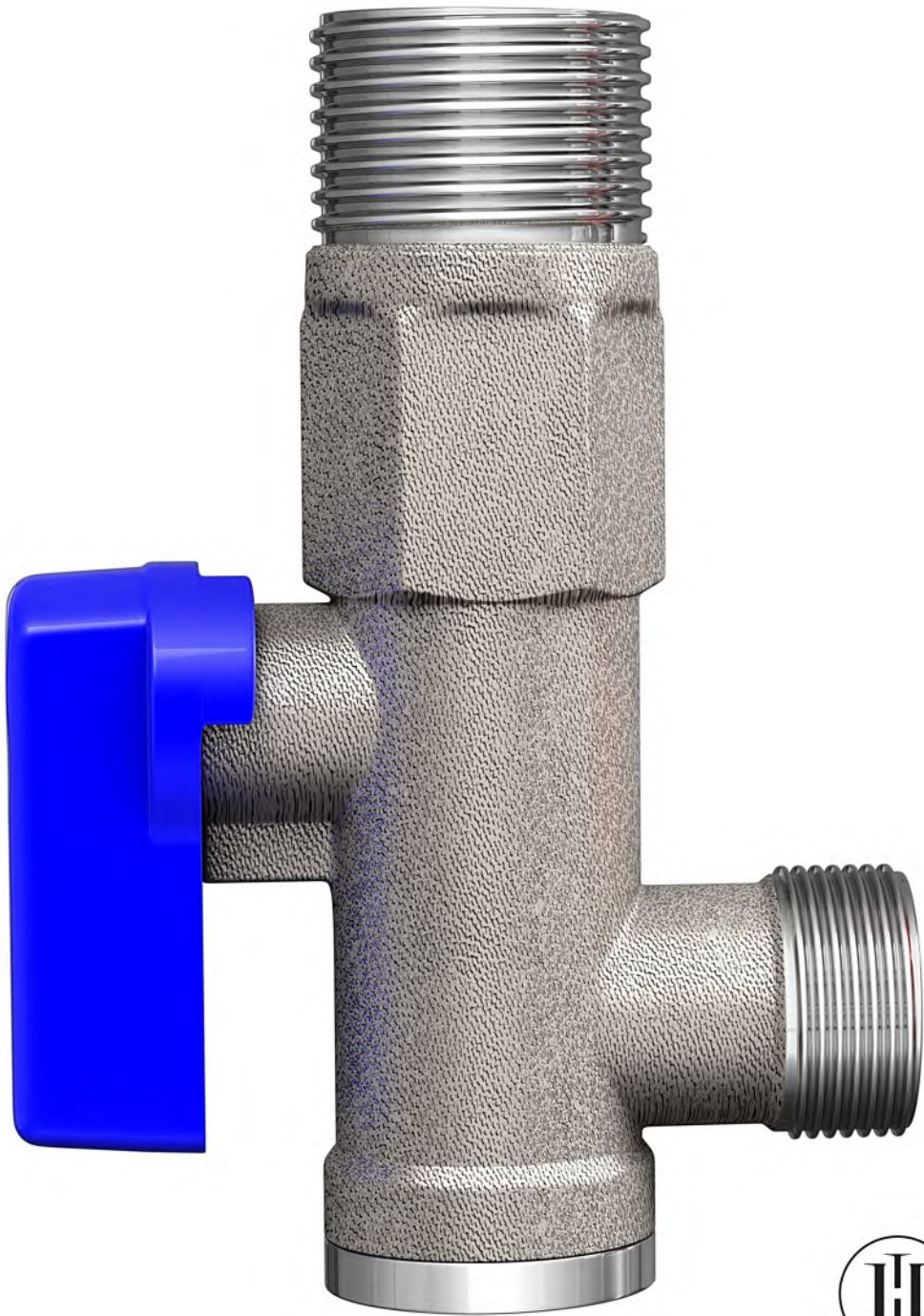

 HocoLex



TÜV INTERCERT
CERTIFICATE

Certificate No. 11-Q-1002725-TIC

WE HEREBY CERTIFY THAT THE QUALITY MANAGEMENT SYSTEM OPERATED BY
Taha Valves Production Industries Co.
 No.207, 13th st., Karafariman st., Sanat blvd., industrial town no.2,
 Bushehr, Iran

IS IN COMPLIANCE WITH THE REQUIREMENTS OF STANDARD
ISO 9001:2008

THIS CERTIFICATE IS VALID FOR THE FOLLOWING ACTIVITIES
Production of all kinds of sanitary valves

AN AUDIT WAS PERFORMED, REPORT No. RC-0911-Q-TIC-MS-1002725-11
 Expiring date 28.09.2022

TÜV INTERCERT

L. Lohr
 Director of Certification Body

MTIC INTERCERT
CERTIFICATE

Certificate No. 20-Q-1502588-MTIC

WE HEREBY CERTIFY THAT THE QUALITY MANAGEMENT SYSTEM
Taha Valves Production Industries
 Taha Valves Company, 6th
 Town, Bushehr, Iran

IS IN COMPLIANCE WITH THE REQUIREMENTS OF STANDARD
ISO 9001:2008

THIS CERTIFICATE IS VALID FOR THE FOLLOWING ACTIVITIES
**Production of all Kinds of Sanitary
 and Pipe**

AN AUDIT WAS PERFORMED, REPORT No. RC-4658-Q-MTIC-MS
 Expiring date 14.08.2023

MTIC

L. Lohr
 Director of Certification Body

